

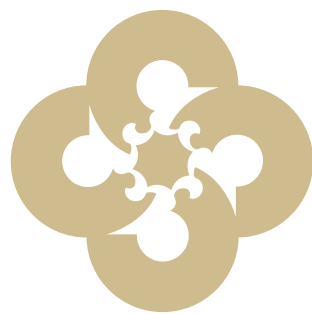

CROFT

Full Range of
Sliding Door Furniture





British designers and manufacturers of the finest architectural hardware

Welcome

We are delighted to showcase our full range of sliding door furniture, which includes our new contemporary Pull designs.

Available in rectangular, square and round options with a wide choice of sizes, depths and fixing options, the new Pulls provide a sleek and tailored aesthetic, with all the quality and sophistication expected from the Croft portfolio.

About Croft

Based in the heart of England and with a family manufacturing history dating back to 1868, Croft have a long-standing reputation for manufacturing excellence within our field. Our unique blend of traditional handcraft techniques infused with state-of-the-art machinery and seamless design innovations, ensures only the most alluring pieces of quality hardware are produced.



“Croft products are designed and manufactured in our Willenhall factory to perfectly meet the requirements of high end residential and commercial projects around the world.”

For our full range of door, window and interior hardware please visit our website or request the full Croft brochure.

www.croft.co.uk

Full Range of Sophisticated Sliding Door Furniture



Five new exciting Pull designs

Available in Rectangular, Square
and Round options

Contents

Explore our extensive range of sliding door furniture.

Offering all the choice, flexibility and ease for your project.

Rectangular Pulls	6
Square Pulls	8
Round Pulls	10
Edge Pulls	12
Flush Rings, Latch and Lock Handles	14
How to order	
Rectangular Pulls	16
Square Pulls	17
Round Pulls	18
Choice of finishes	19

British manufacturers of the finest architectural hardware



Rectangular Pulls

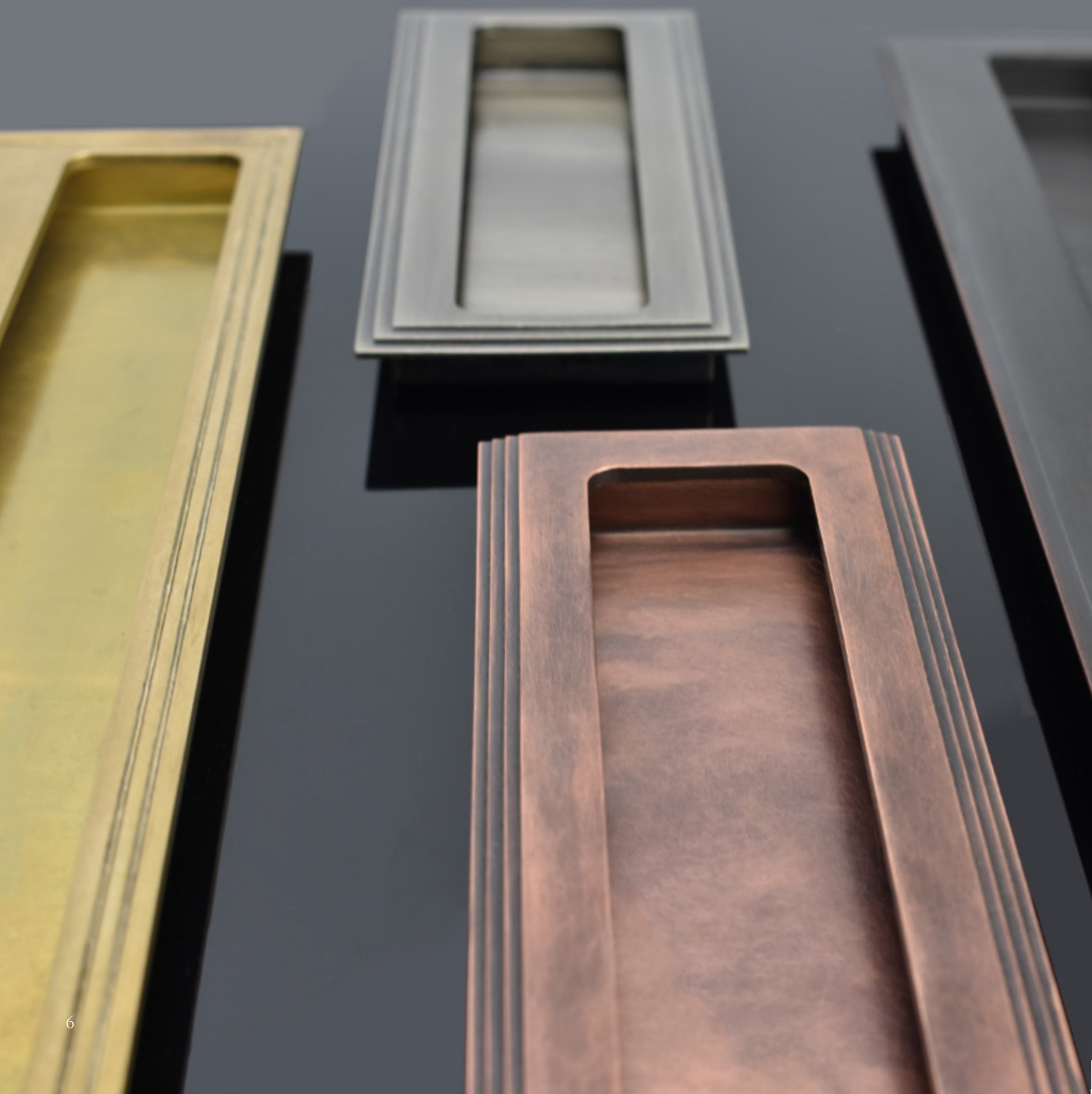

Sleek and elegant Rectangular Pulls

Providing your project with a wonderful choice of options, our beautifully refined Rectangular Pulls are available in twelve sizes and come with a selection of five functions and three fitting options to suit.

We also provide a bespoke length option on request.



Please see page 16 for your full choice of Rectangular Pull options and your guide on how to order.

Five exquisite designs



2500R Plain



2510R Edge Step



2520R Straight Step

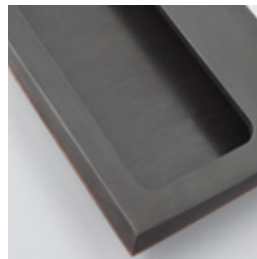

2530R Pillow

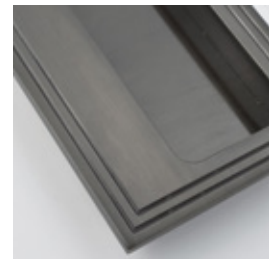

2540R Reeded

Our Pull designs are available in over 20 striking finishes, see page 19

Square Pulls



Classically stylish Square Pulls

Our Square Pulls create an elegant and stylish appearance, harmonising with all styles of sliding doors.

Offering all the choice and flexibility to explore four depth and three lip options to suit.



Please see page 17 for your full choice of Square Pull options and your guide on how to order.

Five exquisite designs



2500SQ Plain

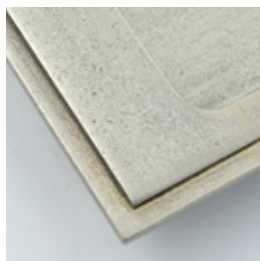

2510SQ Edge Step

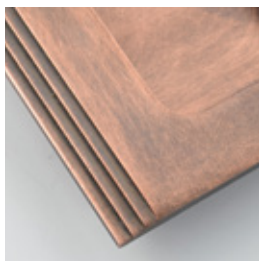

2520SQ Straight Step

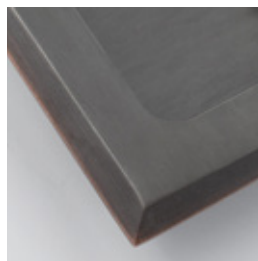

2530SQ Pillow

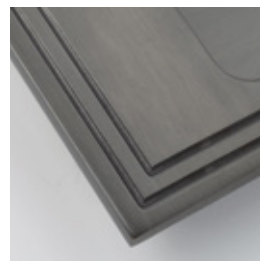

2540SQ Reeded

Our Pull designs are available in over 20 striking finishes, see page 19

Round Pulls



Sophisticated and graceful Round Pulls

Achieve your desired look with our Round Pulls.

With all the choice, flexibility and ease to make your project a real success, four designs in three sizes. Select from three depth options and fixings to suit.



Please see page 18 for your full choice of Round Pull options and your guide on how to order.

Four exquisite designs

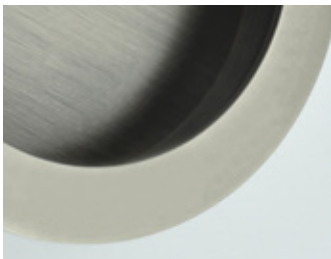

2500RD Plain



2510RD Edge Step



2530RD Pillow

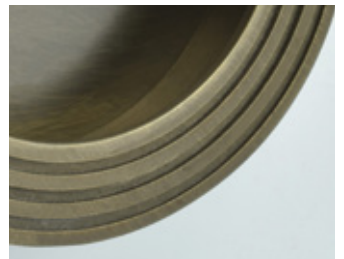

2540RD Reeded

Our Pull designs are available in over 20 striking finishes, see page 19

Edge Pulls

A choice of three solid brass Edge Pulls to match your Croft sliding door hardware.

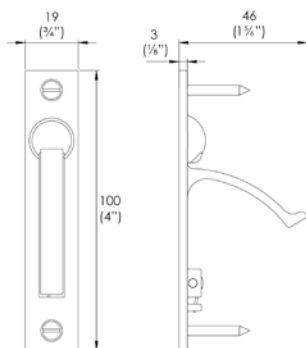
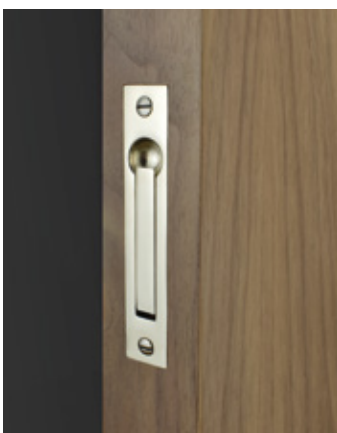

2600 Light Edge Pull

- Slimline design, suitable for lighter sliding doors.
- Easy one-handed operation, with spring return mechanism.
- Available in over 20 finishes.

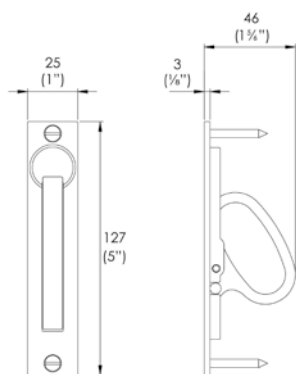

2601 Medium Edge Pull

- A more robust sliding door Pull.
- Designed for smooth and effortless one-handed operation.
- Available in over 20 finishes.

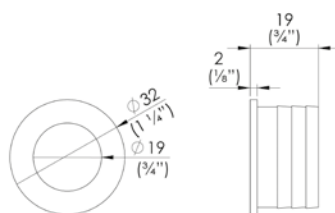

2603 Finger Edge Pull

- A circular Pull with concentric lip to aid grip, creating a one-finger opening.
- Easy fitting, no screws required.
- Perfect accompaniment to our Round Pull designs.
- Pull available in over 20 finishes.



Flush Rings, Latch and Lock Handles



1050



1804



1804A



1804C



1805



1812



1804 Flush Lock Handle
146 x 70mm

Also available in the following versions:

1804L Latch

1804E Euro Profile

1804A Flush Latch Handle
102 x 70mm

1804C Circular Flush Latch Handle
68mm diameter

1805 Flush Ring Handle
65 x 65mm
75 x 75mm
90 x 90mm

1812 Squash Court Handle
89 x 89mm

1813 Fixed version of 1812

2130 Bevelled Edge Flush Pull
76 x 42mm

2134 Plain Cast Flush Pull
76mm (3") & 102mm (4")

2136 Kidney Cast Flush Pull
76mm (3") & 102mm (4")

2138 Flush Pull with Finger Recess
114 x 64mm

1050 Flush Ring
38 x 29mm (1 1/2" x 1 1/8")
50 x 38mm (2" x 1 1/2")
64 x 50mm (2 1/2" x 2")
76 x 57mm (3" x 2 1/4")

How to order Rectangular Pulls

Follow our seven simple steps to build your own product code.

Code example

1. Design 2520R	2. Function B	3. Size 305x64	4. Depth x9	5. Fixing AF	6. Lip OP	7. Finish PN
---------------------------	-------------------------	--------------------------	-----------------------	------------------------	---------------------	------------------------

1. Design

Choose from five rectangular designs (Add 2520R for Straight Step)

2520R



2500R
Plain



2510R
Edge Step



2520R
Straight Step

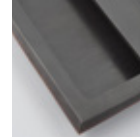

2530R
Pillow

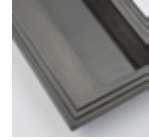

2540R
Reeded

2. Function

Add the corresponding letter to choose your function. (Add B for Bathroom Turn)

2520R-B

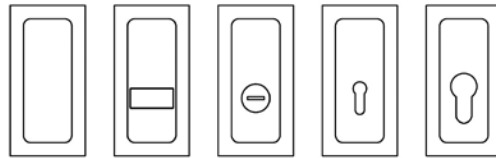

No Function (No code required)
B - Bathroom Turn*
C - Coin Release*
K - Standard Keyhole
E - Euro Profile
*Bathroom Turn side and Coin Release side sold separately

Functions are only recommended on 9mm and 11mm depths for ease of access.

Bathroom (Privacy) Turn also available in Diamond Orientation. Please suffix D to specify (e.g. 2520R-BD)

3. Size

(Add 305 x 64 for 12" x 2.5" 305mm x 64mm)

2520R-B-305x64

Standard Size Chart

Lengths	Widths		
	2" (51mm)	2 1/2" (64mm)	3" (76mm)
4" (102mm)	✓		
6" (152mm)	✓	✓	
8" (203mm)	✓	✓	✓
10" (254mm)	✓	✓	✓
12" (305mm)	✓	✓	✓

Bespoke length options available on request.

Please contact us with your enquiry.

4. Depth

(Add x9 for 9mm depth)

2520R-B-305x64-x9

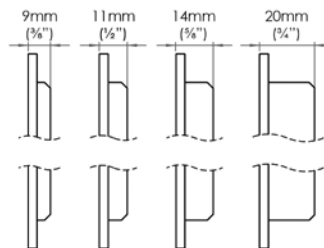

Single Lip and Double Lip: 14mm & 20mm only.

5. Fixing

(Add AF for Adhesive Fix)

2520R-B-305x64-x9-AF

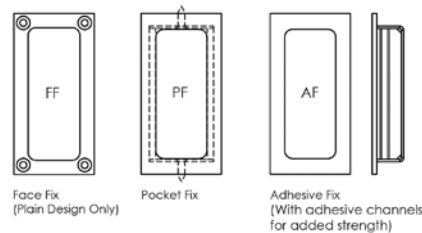

Face Fix (Plain Design Only)
Pocket Fix
Adhesive Fix (With adhesive channels for added strength)

Face Fix: Plain designs only.
Pocket Fix: 14mm & 20mm depths.

6. Lip

(Add OP for Open (No Lip))

2520R-B-305x64-x9-AF-OP

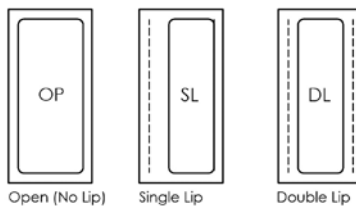

Open (No Lip)
Single Lip
Double Lip

The Open option (no Lip) is available in all Pull sizes.

Single Lip and Double Lip is available in 14mm & 20mm depths only.

7. Finish

(Add PN for Polished Nickel)

2520R-B-305x64-x9-AF-OP-PN



AB AGD AN AUT CP DAB DAN DBMA DORB IBMA IBUL MB
MBK ORB PB PBUL PN PRL SB SBUL SCP SNP SMK

How to order Square Pulls

Follow our seven simple steps to build your own product code.

Code example

1. Design 2530SQ	2. Function C	3. Size 64x64	4. Depth x14	5. Fixing FF	6. Lip SL	7. Finish AB
----------------------------	-------------------------	-------------------------	------------------------	------------------------	---------------------	------------------------

1. Design

Choose from five square designs (Add 2530SQ for Pillow)

2530SQ



2500SQ
Plain



2510SQ
Edge Step



2520SQ
Straight Step

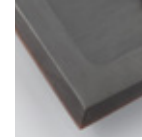

2530SQ
Pillow

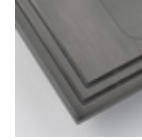

2540SQ
Reeded

2. Function

Add the corresponding letter to choose your function. (Add C for Coin Release)

2530SQ-C



No Function
(No code
required)



B - Bathroom
Turn*



C - Coin
Release*



K - Standard
Keyhole



E - Euro Profile

*Bathroom Turn side and Coin Release side sold separately

Functions are only recommended on 9mm and 11mm depths for ease of access.

Bathroom (B), Coin (C) & Euro (E) not available on 2" Square Pull.

Bathroom (Privacy) Turn also available in Diamond Orientation. Please suffix D to specify (e.g. 2520SQ-BD)

3. Size

(Add 64x64 for 2 1/2" / 64mm)

2530SQ-C-64x64

2" (51mm) 2 1/2" (64mm) 3" (76mm)

Turn and Release not available on 2" wide single Lip recess.

4. Depth

(Add x14 for 14mm depth)

2530SQ-C-64x64-x14

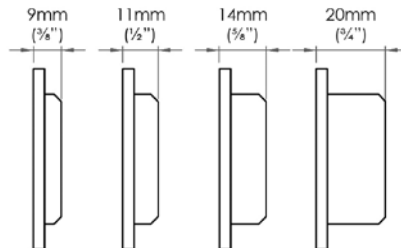

5. Fixing

(Add FF for Face Fix)

2530SQ-C-64x64-x14-FF

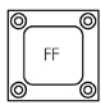

Face Fix
(Plain Design Only)

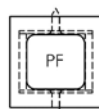

Pocket Fix

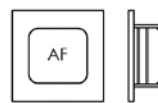

Adhesive Fix
(With adhesive channels
for added strength)

Single Lip and Double Lip: 14mm & 20mm only.

6. Lip

(Add SL for Single Lip)

2530SQ-C-64x64-x14-FF-SL

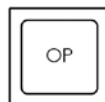

Open (No Lip)
45mm wide

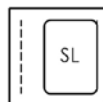

Single Lip
33mm wide

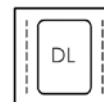

Double Lip
33mm wide

The Open option (no Lip) is available in all Pull sizes.

Single Lip and Double Lip is available in 14mm & 20mm depths only.

7. Finish

(Add AB for Antique Brass)

2530SQ-C-64x64-x14-FF-SL-AB



How to order Round Pulls

Follow our six simple steps to build your own product code.

Code example

1. Design 2500RD	2. Function B	3. Size 76	4. Depth x9	5. Fixing AF	6. Finish PBUL
----------------------------	-------------------------	----------------------	-----------------------	------------------------	--------------------------

1. Design

Choose from four round designs
(Add 2500RD for Plain)

2500RD

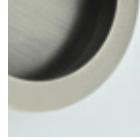

2500RD
Plain



2510RD
Edge Step



2530RD
Pillow

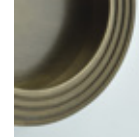

2540RD
Reeded

2. Function

Add the corresponding letter to
choose your function.
(Add B for Bathroom Turn)

2500RD-B

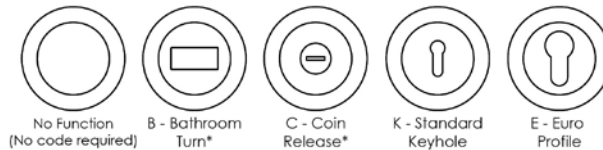

*Bathroom Turn side and Coin Release side sold separately

Bathroom (Privacy) Turn also available in Diamond Orientation. Please suffix D to specify (e.g. 2520RD-BD)

3. Size

(Add 76 for 3" / 76mm)

2500RD-B-76

2" (51mm) 2½" (64mm) 3" (76mm)

4. Depth

(Add x9 for 9mm depth)

2500RD-B-76-x9

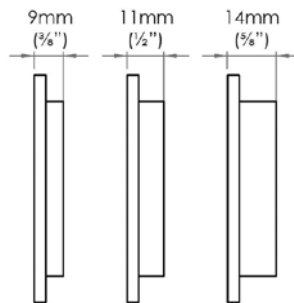

Maximum depth on Round Flush Pull 14mm.

5. Fixing

(Add AF for Adhesive Fix)

2500RD-B-76-x9-AF

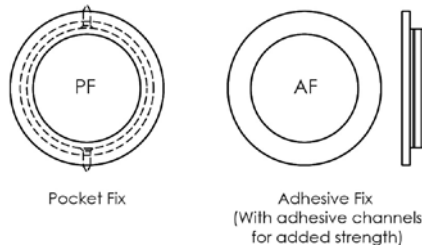

Due to limited protrusion, Face Fix is not available on Rounded Flush Pulls.

Pocket Fix: 14mm only.

6. Finish

(Add PBUL for Polished Brass Unlacquered)

2500RD-B-76-x9-AF-PBUL



Choice of finishes

Our range of Pulls are available in over 20 striking finishes.



AB
(Antique Brass)



AGD
(Aged Brass)



AN
(Antique Nickel)

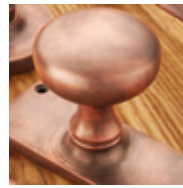

AUT
(Autumn Bronze)



CP
(Polished Chrome)



DAB
(Distressed Antique Brass)



DAN
(Distressed Antique Nickel)



DBMA
(Dark Bronze Metal Antique)



DORB
(Distressed Oil Rubbed Bronze)



IBMA
(Imitation Bronze Metal Antique)



IBUL
(Imitation Bronze Unlacquered)



MB
(Marbled Brass)



MBK
(Matte Black Bronze)



ORB
(Oil Rubbed Bronze)



PB
(Polished Brass)



PBUL
(Polished Brass Unlacquered)



PN
(Polished Nickel)



PRL
(Pearl Nickel)



SB
(Satin Brass)



SBUL
(Satin Brass Unlacquered)

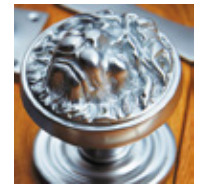

SCP
(Satin Chrome Plate)



SNP
(Satin Nickel Plate)



SMK
(Smoked Brass)

The perfect finishing touch, bringing your project to life

Although the images contained within this literature offer an excellent representation, both printing limitations and the hand application process can result in natural variations in colour and texture.

www.croft.co.uk | T: +44 (0)1902 606493 | E: sales@croft.co.uk



Manufacturers of the finest architectural hardware

Croft Architectural Hardware Ltd
Lower Lichfield Street
Willenhall
West Midlands
WV13 1QQ
England

T: +44 (0)1902 606493
E: sales@croft.co.uk

www.croft.co.uk