

Salice Paolo



TIMELESS

EDIZIONE
EDITION

01

Nuova gamma - *New range*



Salice Paolo



L'AZIENDA / OUR COMPANY



Paolo Salice crea la sua linea di maniglie classiche a cavallo degli anni 40-50, sfruttando il know how acquisito nella lavorazione dell'ottone.

Tecnica, cultura e competenze artigianali si fondono in una gamma completa per stili e finiture, posizionata nella fascia alta del mercato.

Gli ultimi decenni vedono l'ingresso nel settore moderno, dove la competizione ancor più dura, non lascia alternativa alla ricerca della massima qualità e di un design originale, sempre in equilibrio fra sobrietà e personalità.

Lo stabilimento di Cantù vanta sistemi di depurazione delle acque di processo e per l'aria conformi alle più recenti normative in materia. Ed ancora, l'installazione di un sistema di grassaggio ad acqua che elimina totalmente l'uso di solventi, persino quelli oggi dichiarati "non dannosi".

Giunta alla sua terza generazione, la famiglia Salice sta guidando il marchio verso importanti cambiamenti, nel rispetto della sua non comune tradizione e in difesa di una produzione genuinamente Made in Italy.

Paolo Salice creates its own line of classic handles at the turn of 40ties and 50ties, taking advantage of the know-how acquired in the machining of brass.

Technology, culture and craft skills come together in a full range of styles and finishes, positioned at the high end of the market. The last decades saw its entry into the modern ground, where competition is even tougher, and leaves no alternative to the research of the highest quality and original designs, always in balance between sobriety and personality.

The plant in Cantù is equipped with a special purification system for processed water and for the air in compliance with the latest regulations. And yet, the installation of a water degreasing system that eliminates the use of solvents, even those declared today "not harmful".

Now in its third generation, the Salice family is driving the brand to major changes, in accordance with its tradition in defense of a genuinely Made in Italy production.



Ogni prodotto Salice Paolo è disegnato, realizzato e rifinito in Italia con alti standard di qualità. Sull'etichetta di ogni confezione è riportato il codice **Trace Me Code** che consente di verificarne online l'autenticità.

The whole Ento production is designed, made and finished in Italy with high quality standards. Trace Me Code is on every packaging label, allowing the customer to verify online that the purchase is genuine.





TIMELESS. Una nuova gamma / A new range



Con la gamma Timeless, Salice Paolo offre una selezione di maniglie e accessori con la stessa qualità del catalogo Classico, realizzati interamente in ottone, controllati uno ad uno lungo tutto il processo produttivo. Nasce per un'idea di stile più sobrio, facile da inserire in ambienti molto diversi, incredibilmente versatile e contemporaneo.

The Salice Paolo Timeless range offers a selection of handles and accessories with the same quality of the Classic catalogue, made entirely of brass, checked one by one throughout the production process. Born from an idea to have a more sober style, easy to combine in many different environments, extremely versatile and contemporary.



LA NOSTRA LINEA PIÙ VERSATILE OUR MOST VERSATILE RANGE

I modelli TIMELESS Salice Paolo hanno disegni e finiture pensati per abbinarsi facilmente a una gran varietà di stili ed essenze. Sono il complemento ideale per ambienti che spaziano dal Classico al Contemporaneo, passando da tutte quelle sfumature senza tempo tra cui il Déco, il Country, l'Etnico e l'Industrial.

The TIMELESS Salice Paolo models have designs and finishes to be easily combined to a wide variety of styles and woods. They are the ideal complement for environments ranging from classic to contemporary, from all those timeless shades including Deco, Country, Ethnic and the Industrial atmospheres.



Tutta la gamma Timeless è realizzata in Ottone
The full Timeless range is made only in brass
Toute la gamme Timeless est en laiton
Alle Timeless Bereich besteht aus Messing
Toda la gama de la Timeless está hecho de latón
Весь диапазон Timeless изготовлен из латуни



Ogni modello può essere abbinato ad accessori della stessa serie o compatibili.

Salice Paolo può suggerire le combinazioni più collaudate, specialmente dove la scelta è più articolata.

Each model can be combined with accessories of the same series or well-suited.

Salice Paolo can suggest the most established matching, especially where the choice is more challenging.

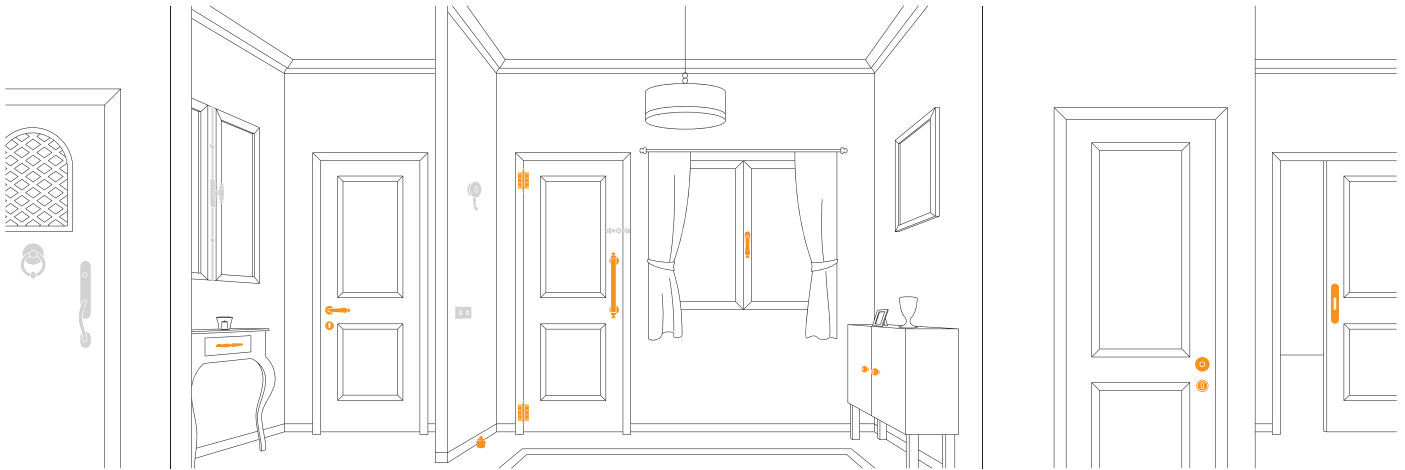

Il catalogo completo si compone di:
The complete catalogue consists of:

- Maniglie / handle
- Maniglie incasso / flush handle
- Dreykipp
- Maniglioni / door pull
- Pomoli / door knob
- Maniglie per mobili / handles for furniture
- Accessori per porte / door accessories



Cristallo
 Crystal
 Cristal
 Kristall
 Cristal
 Кристалл



Molla di ritorno
 Return spring
 Ressort de retour
 Rückholfeder
 Retorno por resorte
 доводчиком



Vetro
 Glass
 Verre
 Glas
 Vidrio
 Стекло



Lunghezza su richiesta
 Custom measure on request
 Longueur sur demande
 Länge auf Anfrage
 Medidas a pedido
 длина по запросу

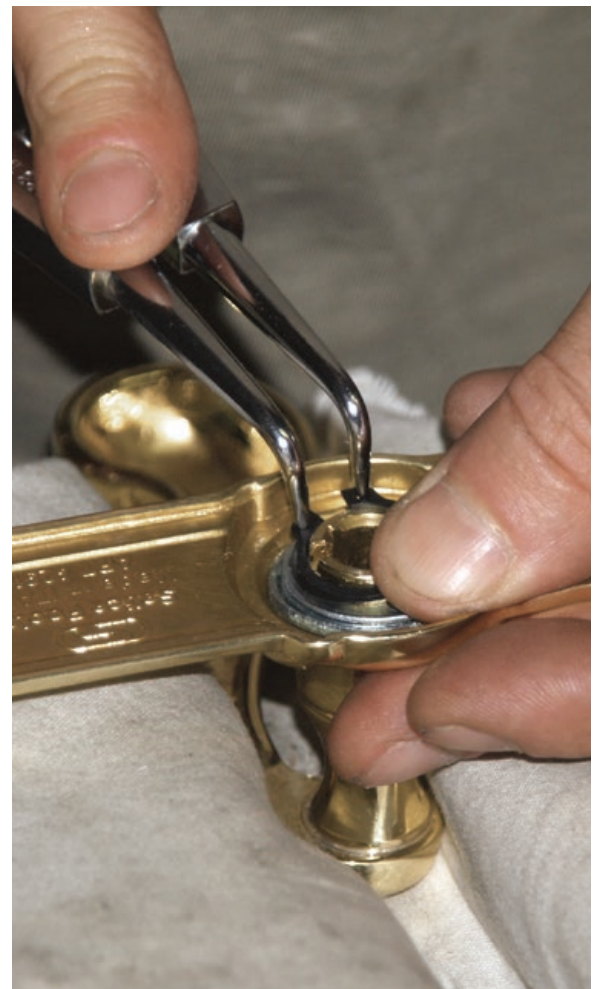



NUOVE FINITURE / NEW FINISHES

La gamma Timeless è proposta in sette finiture tra lucide, satinare e anticate, per coprire il più ampio range estetico.

Il Bronzo graffiato viene introdotto appositamente per questo catalogo, oltre a due novità assolute per il settore: **Oro Champagne**, nelle varianti lucido e satinato.

Sono trattamenti a **bagno Oro 24 Carati**, con processo certificato da Salice Paolo, e costituiscono una raffinata alternativa alle finiture pregiate tradizionali.

*The Timeless range is offered in seven different finishes including polished, satin and antique effects, to cover the broader aesthetic range. The Scratched bronze is introduced specifically for this catalogue, as well as two new finishes for our market: **Champagne gold plated**, in polished and satin variants, are soaked **Gold 24 Carats**, with a certificated process from Salice Paolo, and they are a refined alternative to other traditional fine finishes.*

ORO CHAMPAGNE LUCIDO POLISHED CHAMPAGNE GOLD PLATED

OCL

Novità
New



ORO CHAMPAGNE SATINATO SATIN CHAMPAGNE GOLD PLATED

OCS

Novità
New





WELCOME TO THE PARADISE
PARADISE
WELCOME TO THE PARADISE



YORK
Itamar Harari





INDICE/*INDEX*

Maniglie *Handles*

BORBONE	36
BORROMEIO	28
CASSIA	62
DECO	46
DIAMANTE	80
FRESIA	54
MEDINA	74
SFORZA	68
TUDOR	12
YORK	20

Pomoli *Door knob*

ARUM	94
ASTER	92
BORBONE	40
COSMOS	90
DECO	50
DIAMANTE	85
TUDOR	16
YORK	24

Maniglioni *Door pull*

ARNICA	96
ASCOT	60
BORBONE	41
BORROMEIO	33
CASATI	98
CIPRIANI	100
DECO	51
DIAMANTE	86
TUDOR	17
VICTORIA	61
YORK	25

Maniglie per mobili *Handles for furniture*

ARIANNA	102
ARUM	95
ASTER	93
BORBONE	42
BORROMEIO	34
DECO	52
DIAMANTE	87
FRESIA	59
TUDOR	18
YORK	26

Accessori per porte *Door accessories*

BORBONE	43
BORROMEIO	35
DECO	53
TUDOR	19



Codici Codes

425A	103	2808B	42	4473A	97
425B	103	2810A	52	4473B	97
425C	103	2810B	52	4480	81
445BISA	87	2811A	52	4481	82
445BISB	87	2811B	52	4482	84
445BISC	87	2812A	59	4483BIS	84
445BISD	87	2812B	59	4484	86
460A	95	2813A	59	4485A	85
460B	95	2813B	59	4485B	85
461A	93	2814	99	4485C	85
461B	93	2815	101	4485D	85
2000	13	2900	19	4817	93
2001	14	2901	19	4817BIS	95
2002	16	2902S	15, 31, 39	4889A	91
2003	16	2903	35	4889B	91
2005	21	2904	35	4909S	23
2006	22	2906	43	4910S	83
2007	24	2907	53		
2008	24	2908	53		
2010	29	3010	69		
2011	30	3011	70		
2012	32	3011S	71		
2013	32	3012	72		
2020	37	3013	72		
2021	38	3033A	61		
2022	40	3033B	61		
2023	40	3250	63		
2600	17	3251	64		
2601	17	3251S	57, 65		
2602A	25	3252	66		
2602B	25	3253BIS	66		
2603	33	3255	55		
2605	41	3256	56		
2607	51	3257	58		
2700	16	3258BIS	58		
2701	24	3335	47		
2704	40	3336	48		
2706	50	3336S	49		
2800	18	3337	50		
2801	18	3338	50		
2802A	18	4205	75		
2802B	18	4206	76		
2804A	26	4206S	77		
2804B	26	4207	78		
2805A	34	4208	78		
2805B	34	4326A	60		
2808A	42	4326B	60		

TUDOR

Studio Salice Paolo





TUDOR



2000

| 50 |

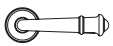

| 50 |

| 50 |

73

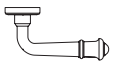

| 145 |





TUDOR



 **2001**

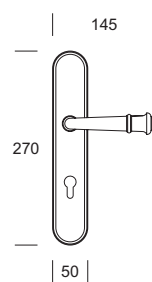



TUDOR



2902S

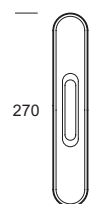

| 50 |





TUDOR



2003

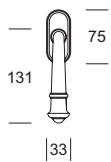

2002

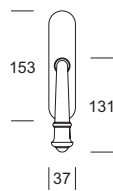

2700

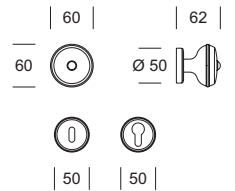



TUDOR

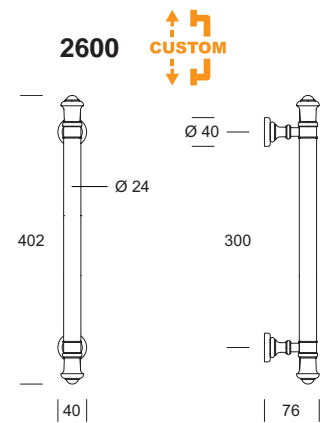
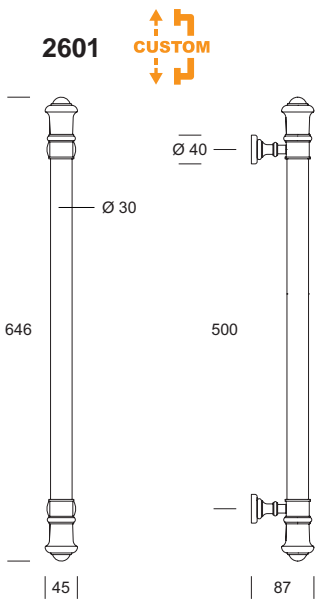



TUDOR



Pomolini per mobile
Knobs for furniture

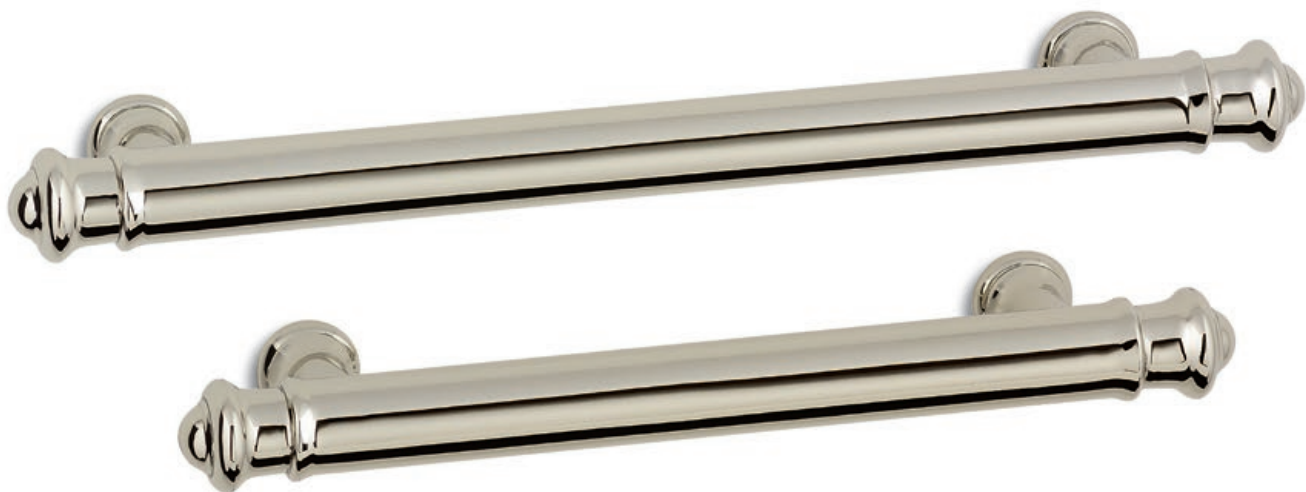

Maniglie per mobile
Handles for furniture

2800



2801



2802A

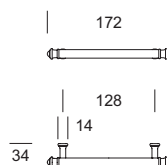

2802B

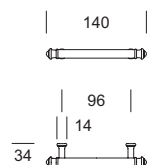



TUDOR



2900



34



41

| 34 |

2901

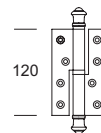

120

| 75 |



YORK

Itamar Harari





YORK



2005

| 50 |



| 50 |

| 50 |

69



| 147 |





YORK



2006

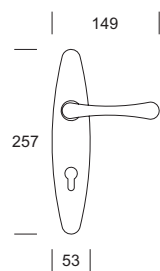



YORK



4909S

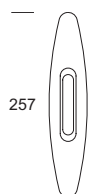

| 53 |





YORK



2008

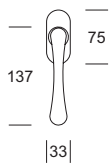

2007

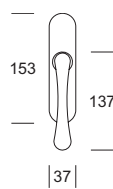

2701

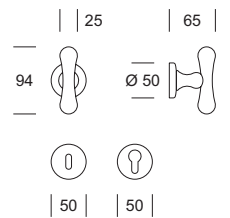



YORK



2602A

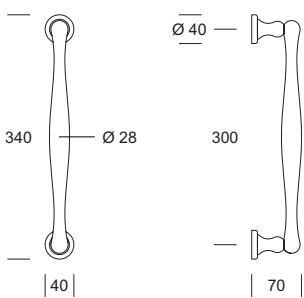

2602B

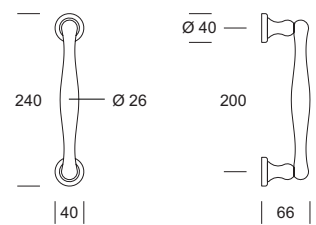



YORK

Maniglie per mobile
Handles for furniture



2804A

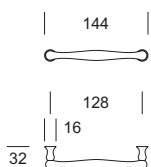

2804B

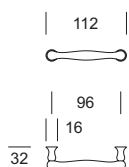



BORRAMEO

Studio Salice Paolo





BORRAMEO



2010

| 50 |

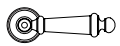

| 50 | | 50 |

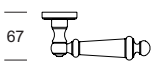

67

| 151 |



BORROMEO



 **2011**

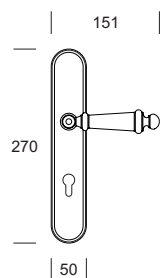



BORROMEO



2902S

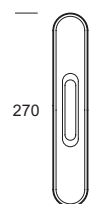

270

| 50 |





BORROMEO



2013

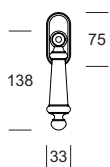

2012

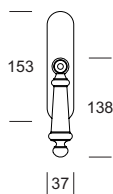



BORROMEO

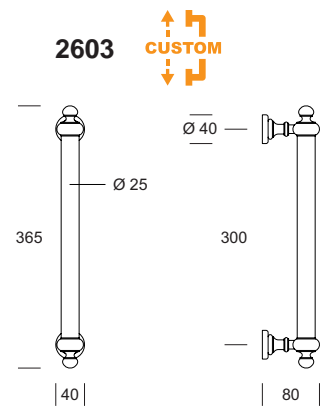
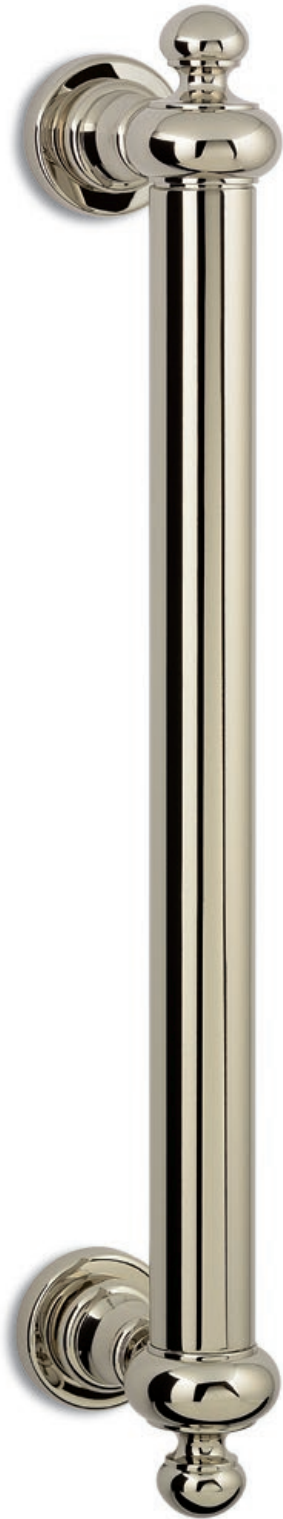



BORROMEO

Pomolini per mobile
Knobs for furniture



2805A



2805B

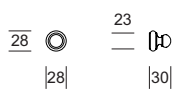

BORROMEO



2903



2904

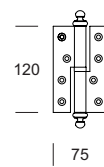

BORBONE

Studio Salice Paolo





BORBONE



2020 

| 50 |

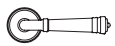

| 50 |

| 50 |

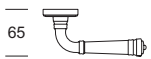

65

| 144 |



BORBONE



 **2021**

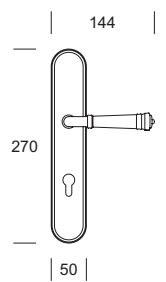



BORBONE



2902S

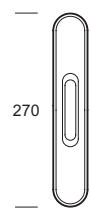

270

| 50 |





BORBONE



2023

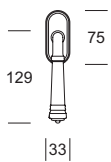

2022

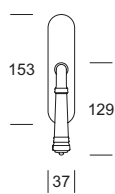

2704

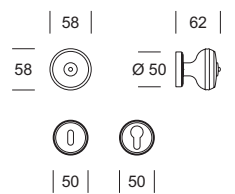



BORBONE

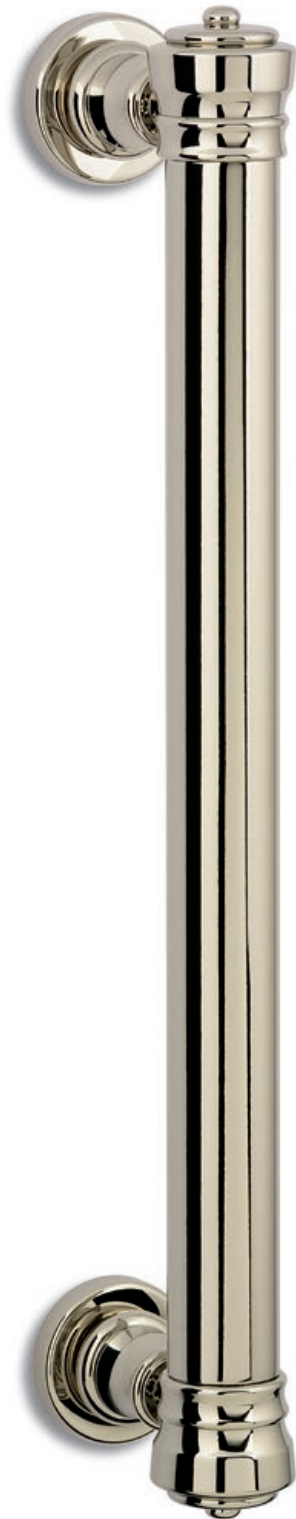

2605

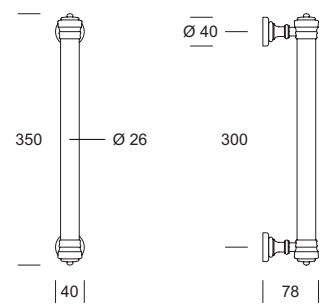



BORBONE

Pomolini per mobile
Knobs for furniture



2808A



2808B

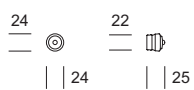



BORBONE



2906

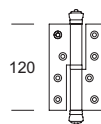

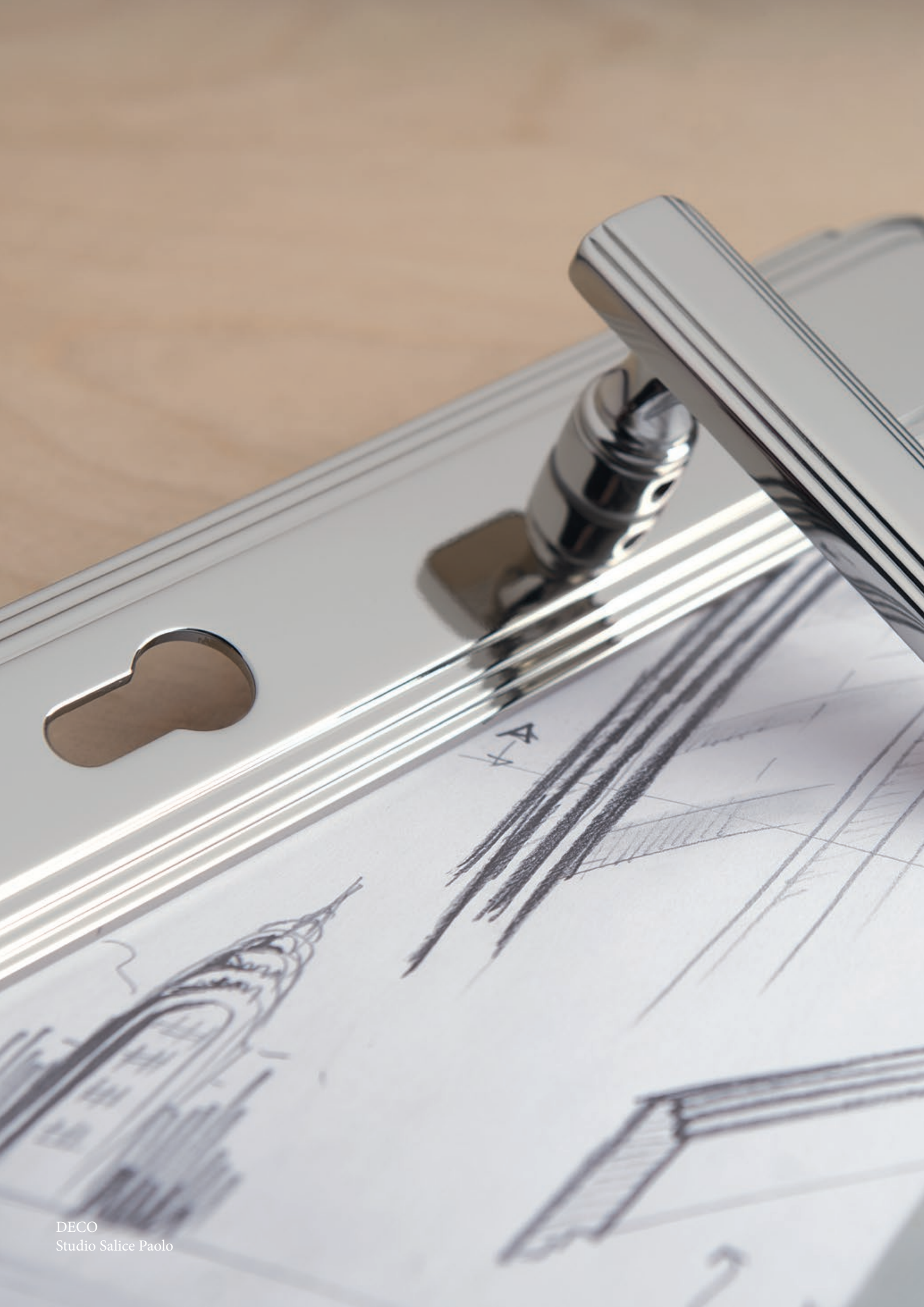



DECO

Studio Salice Paolo





DECO

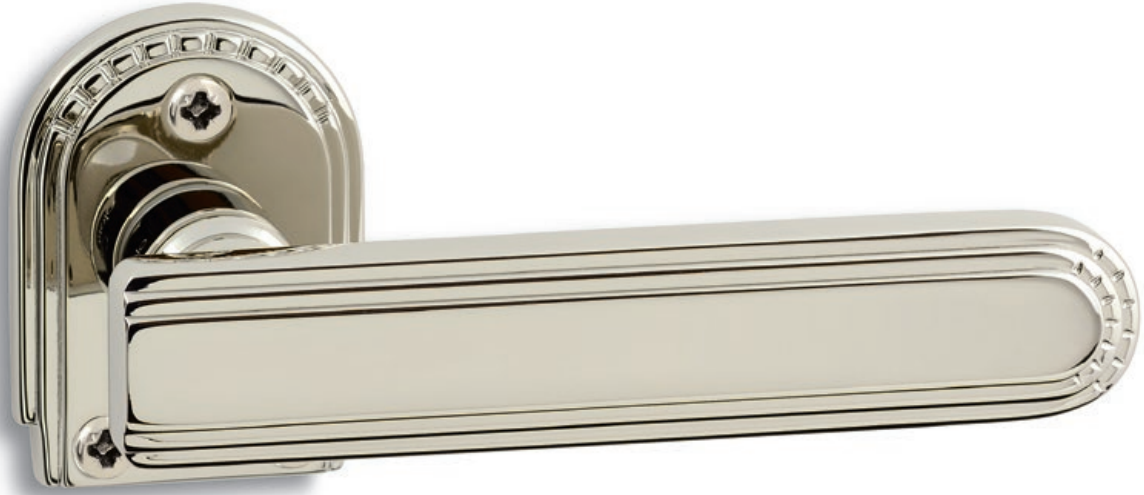

3335



| 42 |



58

| 42 |

| 42 |

50



| 122 |





DECO



3336

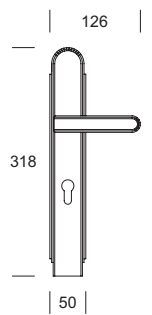



DECO



3336S



318

| 50 |





DECO



3338

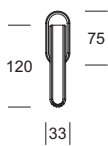

3337

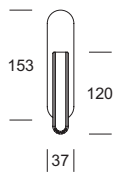

2706

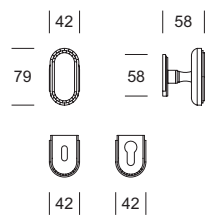



DECO



2607

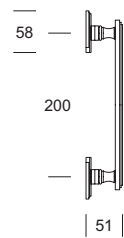



DECO



Pomolini per mobile
Knobs for furniture

Maniglie per mobile
Handles for furniture



2810A

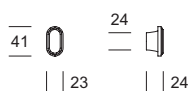

2810B

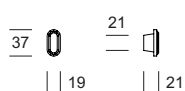

2811A

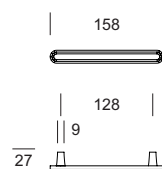

2811B

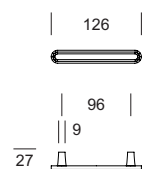



DECO



2907

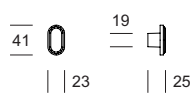

2908

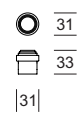

FRESIA

Riccardo Arbizioni





FRESIA



3255



| 50 |



| 50 |

| 50 |

68



| 125 |





FRESIA



3256

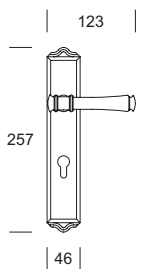



FRESIA



3251S

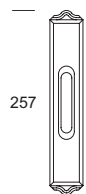

| 46 |





FRESIA



3258BIS

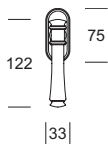

3257

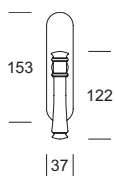



FRESIA



Pomolini per mobile
Knobs for furniture

Maniglie per mobile
Handles for furniture

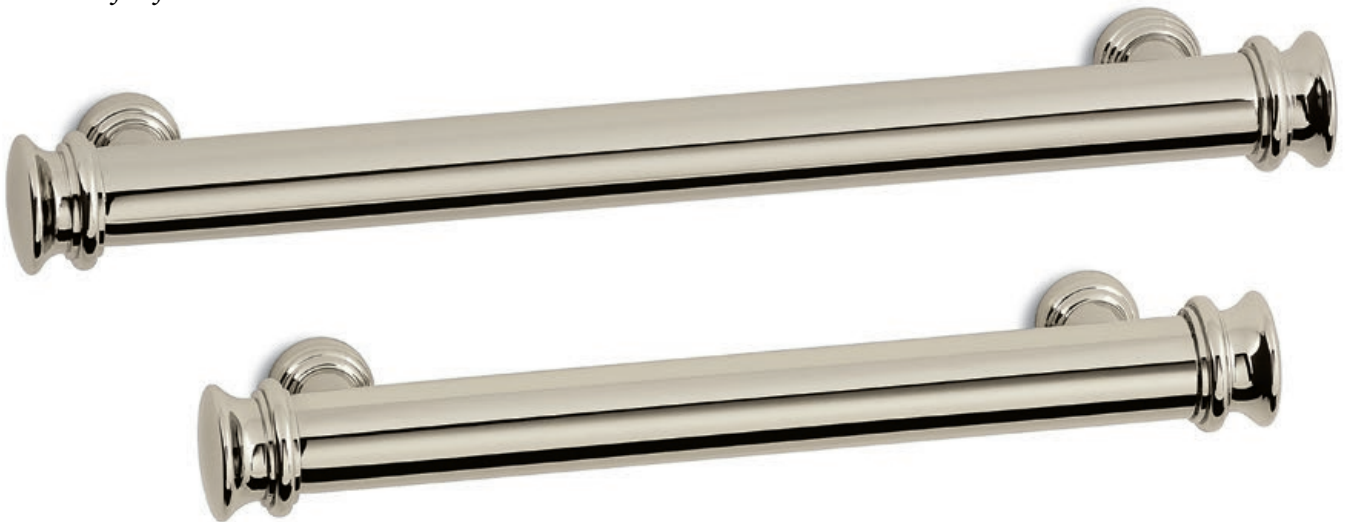

2812A

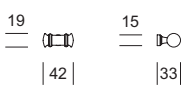

2812B

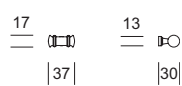

2813A

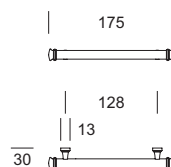

2813B

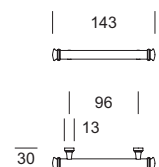



ASCOT



4326A

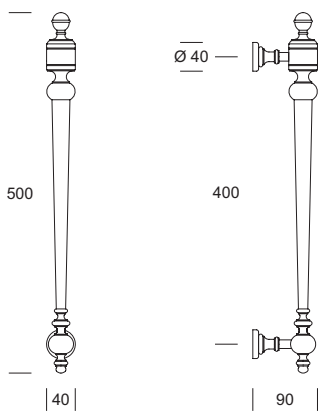

4326B

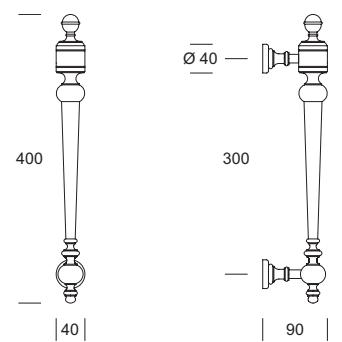



VICTORIA

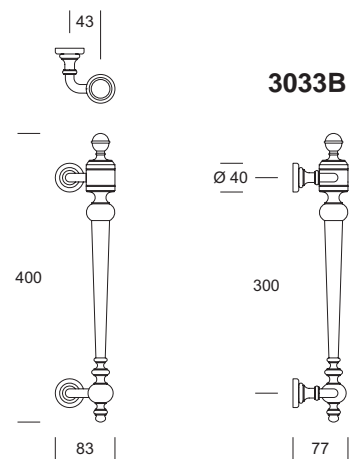
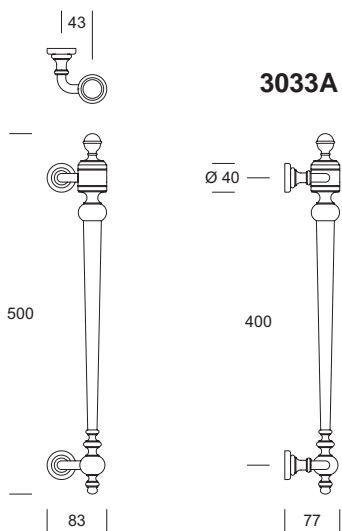

CASSIA

Riccardo Arbizzi





CASSIA



3250



| 50 |



| 50 |

| 50 |

65



| 123 |





CASSIA



3251

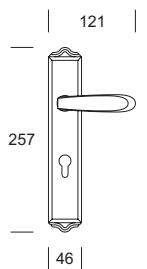



CASSIA



3251S

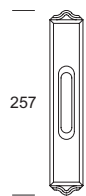

257

| 46 |





CASSIA



3253BIS

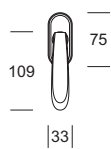

3252

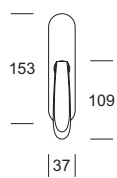



SFORZA

Studio Salice Paolo





SFORZA



3010 

| 50 |

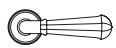

| 50 |

| 50 |

69

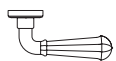

| 145 |





SFORZA



 **3011**

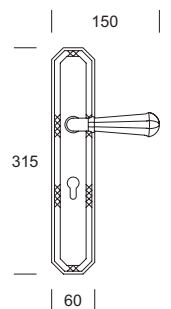



SFORZA



3011S

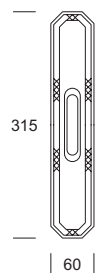

315

60





SFORZA



3013

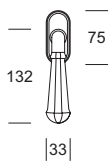

3012

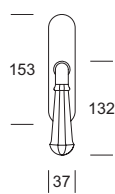



MEDINA

Studio Salice Paolo





MEDINA



4205



| 50 |



| 50 |

| 50 |

60



| 140 |





MEDINA



 **4206**

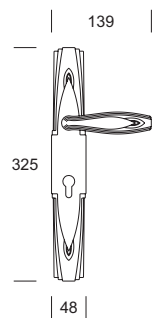



MEDINA



4206S



| 48 |





MEDINA



4208

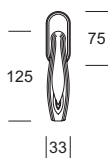

4207

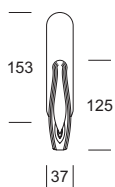



DIAMANTE

Studio Salice Paolo





DIAMANTE



4480



| 50 |

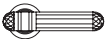

| 50 |

| 50 |

70



| 140 |





DIAMANTE



4481

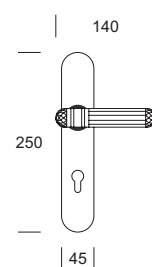



DIAMANTE



4910S

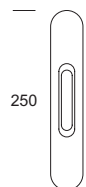

250

| 45 |





DIAMANTE



4483BIS

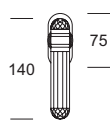

|33|

4482

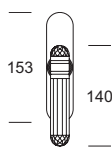

|37|



DIAMANTE



4485A

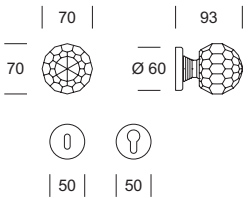

4485B

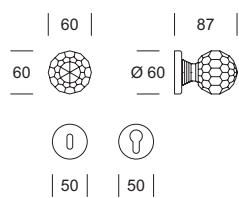

4485C

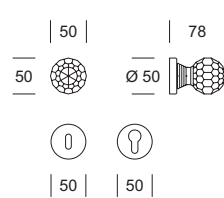

4485D

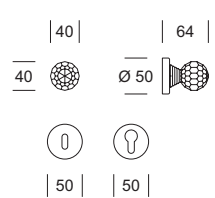



DIAMANTE



4484

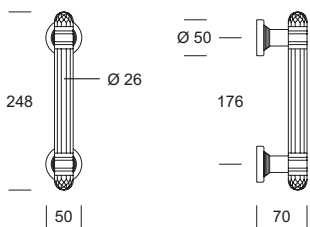



DIAMANTE

Pomolini per mobile
Knobs for furniture



445BISA 

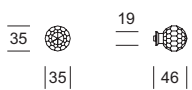

445BISB 

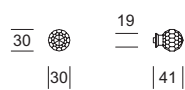

445BISC 

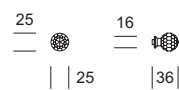

445BISD 

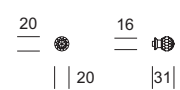



DIAMANTE
Studio Salice Paolo



COSMOS

Studio Salice Paolo





COSMOS



4889A

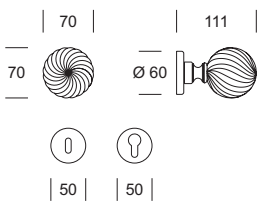

4889B

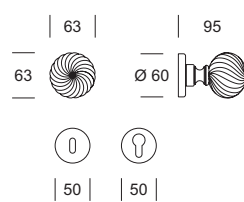

ASTER

Studio Salice Paolo





ASTER



Pomolini per mobile
Knobs for furniture



4817



| 70 | | 98 |

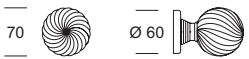

○ ○
| 50 | | 50 |

461A



461B

$\frac{30}{|30|}$ ● $\frac{18}{|42|}$ ●

$\frac{25}{|25|}$ ● $\frac{18}{|35|}$ ●



ARUM

Studio Salice Paolo





ARUM



Pomolini per mobile
Knobs for furniture



4817BIS



| 70 |

| 66 |

70



Ø 60



| 50 |

| 50 |

460A



30



| 30 |

18



| 32 |

460B

25



| 25 |

18



| 27 |



ARNICA

Studio Salice Paolo





ARNICA



4473A

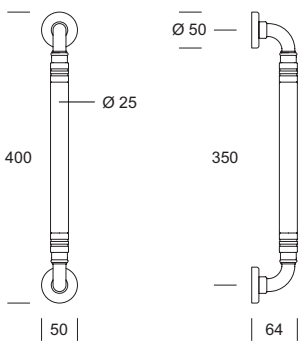

4473B

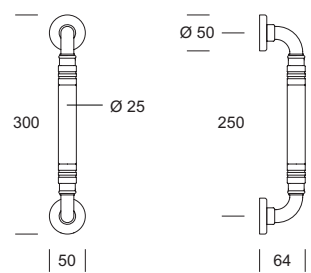

CASATI

Studio Salice Paolo





CASATI



2814

CUSTOM

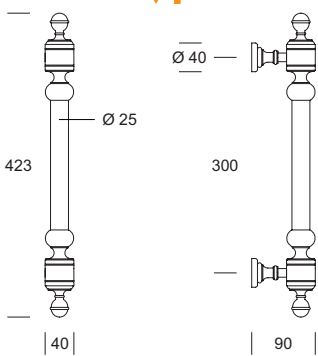

CIPRIANI

Studio Salice Paolo





CIPRIANI



2815

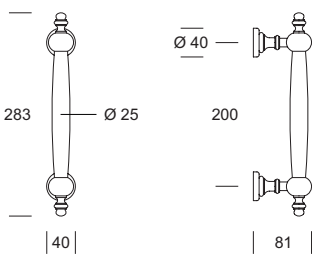

ARIANNA

Studio Salice Paolo



ARIANNA

Pomolini per mobile
Knobs for furniture



425A

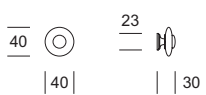

425B

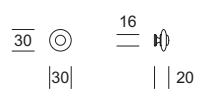

425C

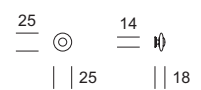



FINITURE / FINISHES



NL

nichel lucido
polished nichel
nichel poli
Poliertes Nichel
nichel brillo
Блестящая никель



OL

ottone lucido
polished brass
laiton poli
Poliertes Messing
laton brillo
Блестящая латунь



BG

**Novità
New**

bronzo graffiato
scratched bronze
bronze rayé
Zerkratzt Bronze
brunito rayado
бронза поцарапан



ETR

Etrusco
Этрусско Этрусский стиль

**OCL****Novità
New**

oro champagne lucido
polished champagne gold plated
champagne doré poli
polierter Champagner-Gold
dorado champagne brillo
золотой блеск шампанского

**OCS****Novità
New**

oro champagne satinato
satin champagne gold plated
champagne doré satiné
satiniertes Champagner-Gold
dorado champagne satinado
шампанского позолотой

**CR**

Cromo
Chrome
Chromé
Chrom
Cromato
Хром



INFORMAZIONI TECNICHE / TECHNICAL INFORMATION

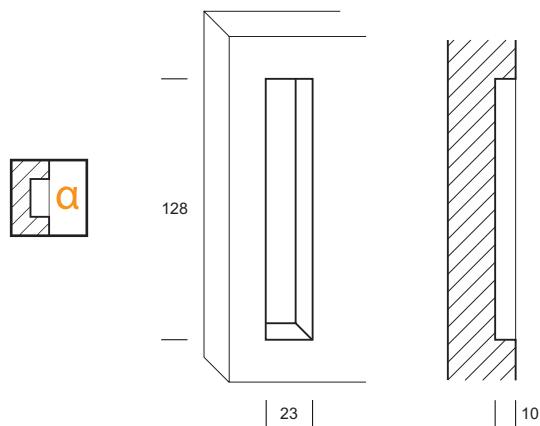

Fresatura maniglia incasso
 Milling of fitted handle
 Fraisage poignée encastrée
 Fraesen Griff Einnahme
 Fresado del tirador empotrado
 Врезка ручек

GERMAN KIT DISPONIBILE ANCHE PER LA GAMMA TIMELESS*
 GERMAN KIT AVAILABLE ALSO FOR THE TIMELESS RANGE*

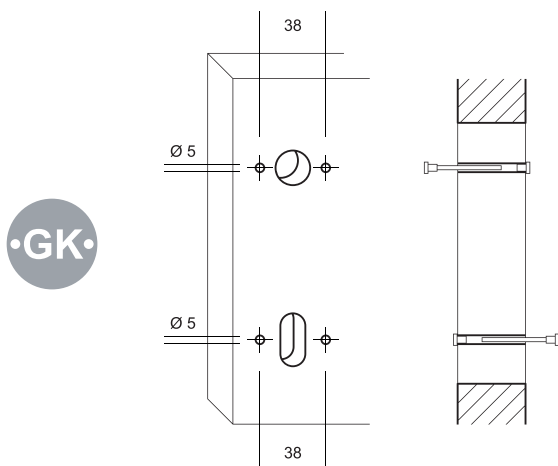

Fori passanti per sottorosette
 Through holes for roses metal bosses
 Trous passage pour bossette de rosace
 Durch Löcher für Metallschildchen für Schilder
 Agujeros a través por placa en metal para boqueta
 Сквозные отверстия для крепления подрозетников

Il German Kit GK è la nuova guarnitura Salice Paolo per tutte le situazioni in cui non è possibile usare il sistema standard di sottorosette, ad esempio con spessori ridotti o scarsa tenuta del legno. Due tiranti filettati fissano saldamente ogni coppia di sottorosette alla porta, attraverso due fori passanti con interasse 38 mm.

Il sistema è perfettamente compatibile con le rosette tradizionali ed è disponibile nelle versioni per bocchette Patent e Yale.

The GK German Kit is the new Salice Paolo fixing kit for all those circumstances when the standard subrose fixing system is not an option, i.e. when door thicknesses are very thin or in case of poorness of the timber. Two threaded rods firmly secure both subroses to the door, through 2 holes with a center distance of 38 mm.

The system is fully compatible with traditional roses and is available in versions for both Patent and Yale escutcheons.

*Eccetto DECO / Except DECO



Salice Paolo

SALICE PAOLO srl
Via Domea, 45
22063 Cantù (CO) Italy
T +39 031 714520
F +39 031 706177
info@salicepaolo.it
www.salicepaolo.it

Si ringrazia LAURAMERONI per le porte e gli elementi d'arredo che compaiono alle pagine:
Thanks to LAURAMERONI for the doors and the pieces of furniture shown on pages:
8-9, 20, 62, 68, 74, 80, 92, 96, 98
www.laurameroni.com

Si ringrazia ARNABOLDI INTERIORS per le porte che compaiono alle pagine:
Thanks to ARNABOLDI INTERIORS for the doors shown on pages:
12, 28, 94
www.arnaboldiinteriors.it

Art direction, concept, product photo: Davide Diliberto  www.davidediliberto.it
Fotolito: BASE GREEN AGENCY - Casaleto Lodigiano (LO)
Stampa: GRAFICA GIOIA - Cantù (CO)